

PRODUCTION PROGRAM

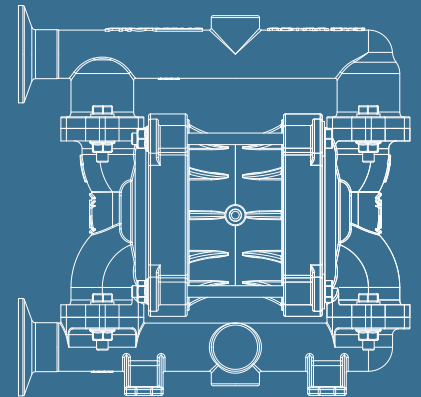

EU product
Made in Italy

2022

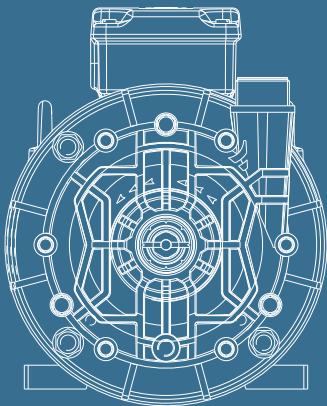
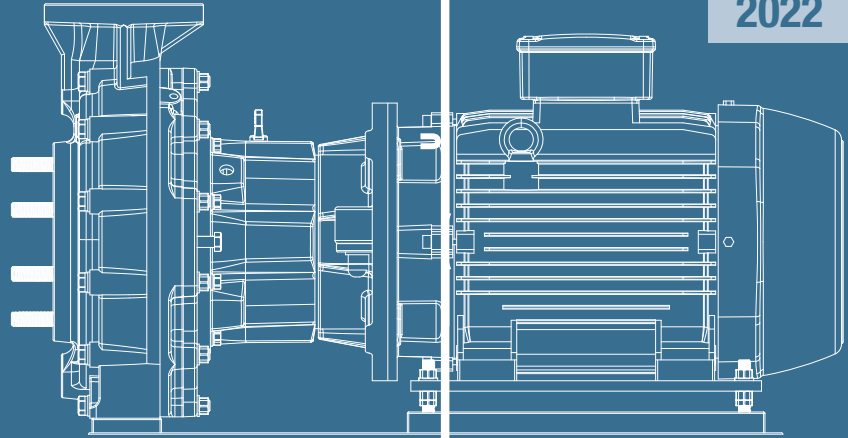
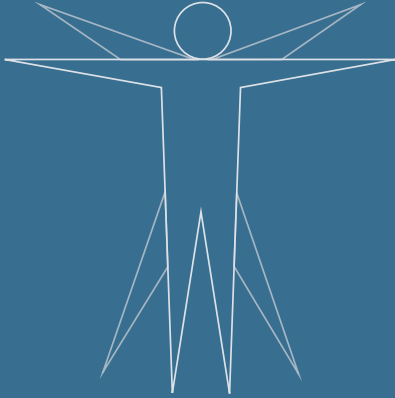

**PUMPS
FOR CORROSIVE
& AGGRESSIVE
LIQUIDS**

**DESIGNING &
MANUFACTURING
*PNEUMATIC &
CENTRIFUGAL PUMPS***



SINCE 1975

EN

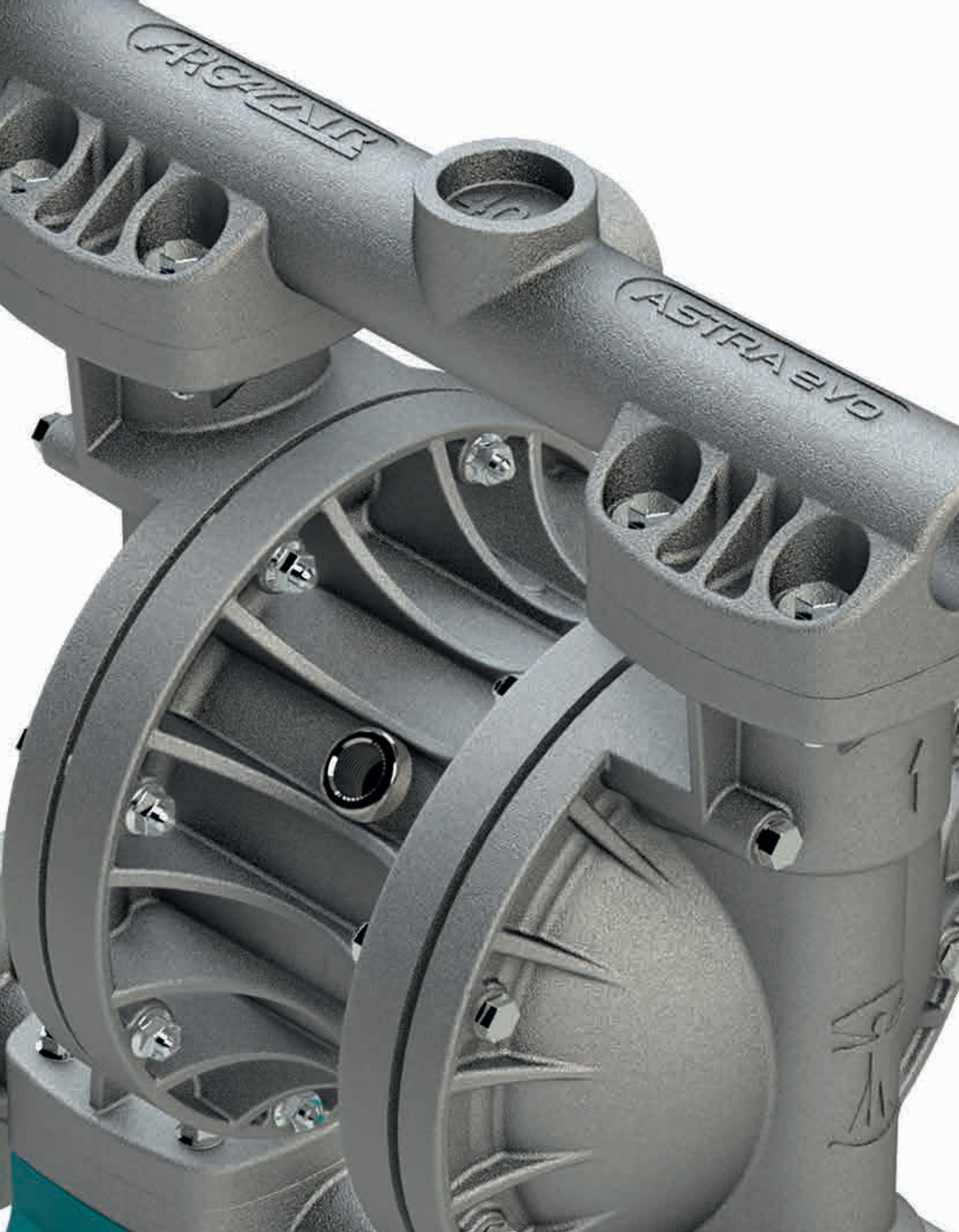



AODD
pumps
pag. 08



Thermoplastic
Self-priming
Centrifugal
Pumps
pag. 14



Thermoplastic
Handling Centrifugal Pumps
pag. 16-17
ISO 2858 Centrifugal Pumps
pag. 18-19



Fiberglass (FRP)
ANSI B 73.1
Centrifugal
Process & Sump
Pumps
pag. 21-24



Thermoplastic
Centrifugal
Sump
Pumps
pag. 25-26

#INDEX

DESIGN

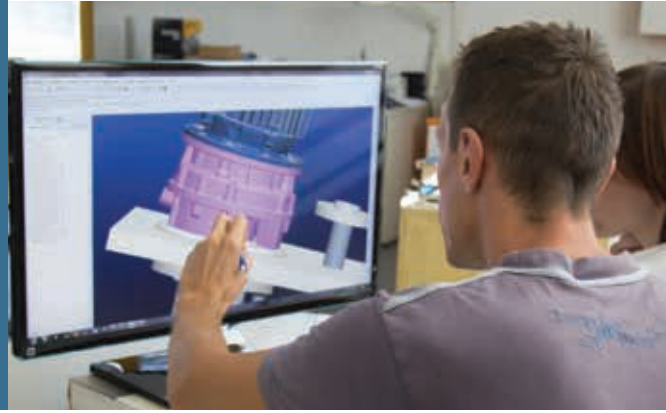

MACHINE



INJECT

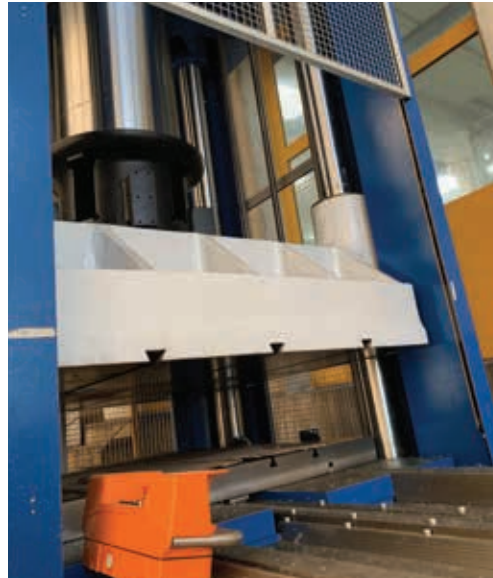

ASSEMBLE



TEST



PUMP MANUFACTURERS SINCE 1975

ARGAL boasts forty years of activity in the invention and production of pumps made of thermoplastic material, compounds and corrosion-resistant metal alloys. During the past decade, significant efforts were directed to research and development on the entire production. Such an effort resulted in entirely new or renovated pump ranges.

Our mission is a continuous and constant technological improvement, along the path of innovation instead of emulation.

How? By offering the best technical performance and engineering obtaining the leadership in performance while providing appropriate responses to the needs of market dynamics by realizing a “State-of-the-art quality.

Today the company has an extensive range of pumps in various constructions for industrial applications requiring temperatures ranging from -40°C to $+120^{\circ}\text{C}$, with load capacities up to $1700\text{ m}^3/\text{h}$ -head over the 100 m.





M

MATERIALS



Polypropylene



Ethylene-Trifluoro Ethylene



Ultra High Molecular Weight Polyethylene



Polyvinyl Chloride



Polyvinylidene Fluoride



Poly Tetra Fluoro Ethylene



Fiberglass

+GLASS

Glass reinforced

+CARBON

Carbon filled



Aluminum



Stainless Steel (low Carbon)



Stainless Steel



Bronze



C

CERTIFICATIONS/WARRANTY



Atex



Food and Drug Administration



European Conformity



Eurasian Conformity



12 months



24 months



60 months



#CONTENTS



TECHNOLOGY



Sealless



Sealed



Self-priming



Submersible



SERIES

1 = TECHNOLOGY

T Sealless

Z Sealed

D Double

K Vertical

2 = CONSTRUCTION

M Close-coupled

G Long-coupled

D Diaphragm

M Close-coupled

3 = RANGE NAME

“P” RIMA

“S” ATURNevo

“Q” UANTUM

“E” QUIPRO

#AODD PUMPS



The AODD (Air-Operated Double Diaphragm) pumps are made for moving corrosive, abrasive, viscous, clean liquids or with solids in suspension. They can operate in dangerous areas (ATEX). Our AODD pumps can vary the flow and are non-stalling, dry-running, self-priming and easy to maintain.





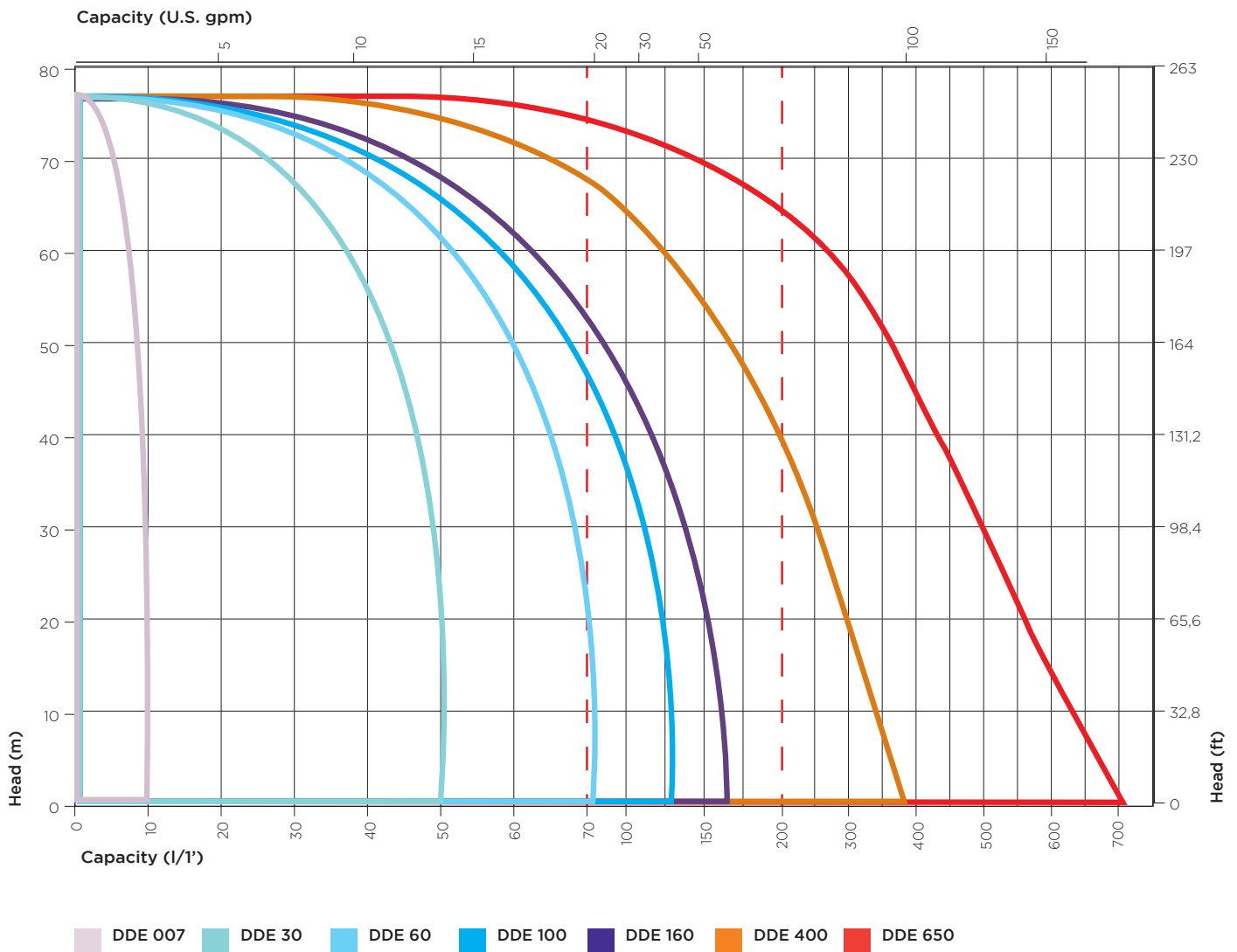



ATEX: Ideal for operating in explosive atmospheres according to the ATEX normative **Zone 2** (II 3G Ex h IIB T4 Gb X | II 3D Ex h IIB T135°C Db X) and ATEX **Zone 1** (II 2G Ex h IIB T4 Gb X | II 2D Ex h IIB T135°C Gb X).



- Optimised air consumption improved by a Modern air distribution system;
- Working sensitivity improved (start from 1 bar);
- Bigger inlet pipe for guaranteeing the best performance ever when pumping viscous liquids.
- Advanced caps for a longer lifecycle of the

membranes and an easy maintenance;

- Distributor protected from atmospheric agents thanks to a free-acid armour;
- Free ice air-exhaustive system;
- Low-noise integrated muffler (up to model 160).

ASTRAevo (*)		Flow rate (l/min")	Ports (inch)	Materials	Solids (mm)
DDE 007		10	1/4"	• PP+G • PVDF+C • POMc+G	1.5
DDE 15		15	1/4"	• PP+G • PVDF+C • ALU • AISI 316L	3.5
DDE 20		20	3/8"		
DDE 30		30	1/2"		
DDE 60		76	1/2"	• PP+G • PVDF+C • ALU • AISI 316L	3.8
DDE 80		105	3/4"	• PP+G • PVDF+C • ALU • AISI 316L	5.5
DDE 100		130	1"		
DDE 160		170	1"	• PP+G • PVDF+C • ALU • AISI 316L	6
DDE 400		370	1 1/2"	• PP+G • PVDF+C • ALU • AISI 316L	7
DDE 650		715	2"	• PP+G • PVDF+C • ALU • AISI 316L	9

MISTRAL (DDM)



BENEFITS & FUNCTIONALITIES

- Extremely efficient;
- Designed for continuous applications ;
- Sturdy construction, 5-year guarantee;
- The safest solution in dangerous atmospheres or with risk of explosion (ATEX Zone 1) .



Port size: 3" - 4"
Capacity: from 70 to 1280 l/m'

Wetted section AISI 316 L BR

Temperatures +250° -20° (PTFE diaphragms)
 +80° -40° (NBR, EPDM, diaphragms)

MISTRAL SOLID (DDM)

Port size: 3"

Wetted section UPPE

Temperatures +95° -20° (PTFE diaphragms)
 +80° -40° (NBR, EPDM, diaphragms)

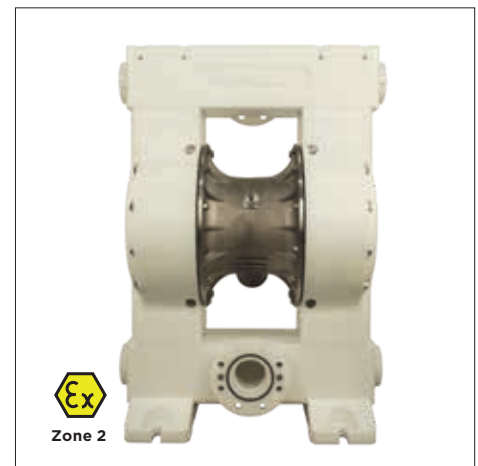

AIRSATURN (DDM)

Port size: 3" - 4"

Wetted section FRP

Temperatures +100° -20° (PTFE diaphragms)
 +80° -40° (NBR, EPDM, diaphragms)

TECHNICAL DATA	300 (3")	400 (4")
Maximum Capacity Litres/Minute	1100	1280
Materials of Pump Housings & Central Block	AISI 316L • BRONZE • UPPE • FRP	AISI 316L • BRONZE • FRP
Fluid Port (ISO-ANSI Flange) Intake & Discharge Connections	3" DN80	4" DN100
Air Inlet	¾" F NPT	¾" F NPT
Air Exhaust (included silencer)	1" F NPT	1" F NPT
Maximum Working Pressure	8 bar	8 bar
Maximum Cycles per Minutes	96	96
Max. Discharge Volume/Cycles	8,5 litres	8,5 litres
Maximum Solids Particle Size	11 mm	13 mm
Suction Lift (dry)	6 m	4,5 m

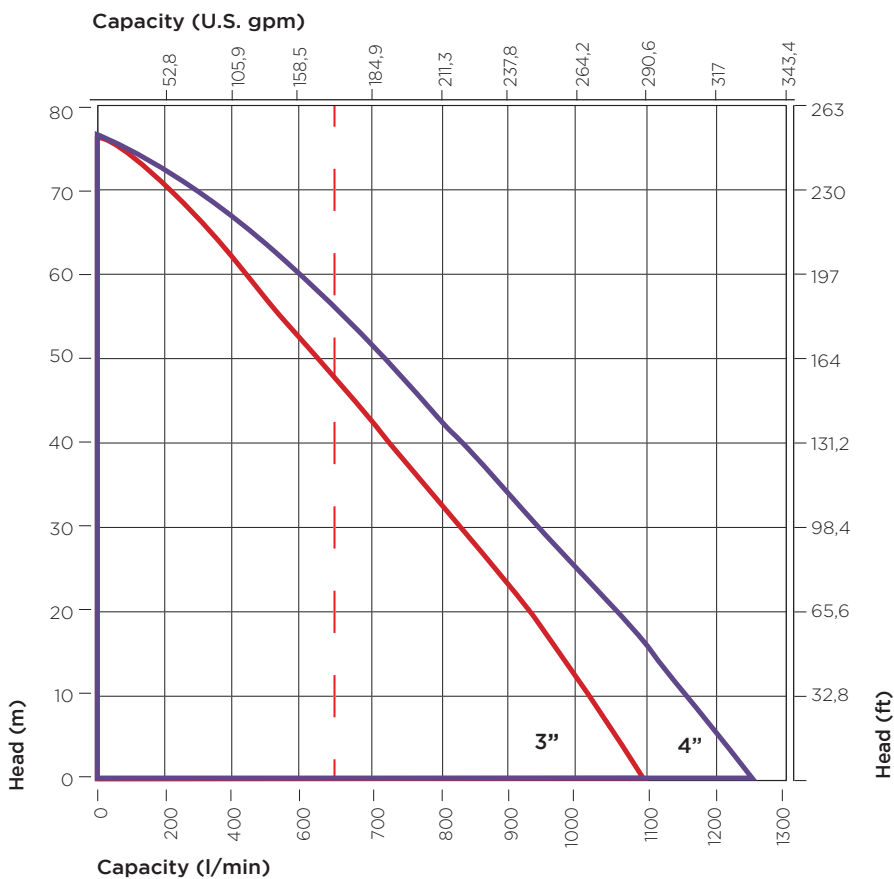

BENEFITS & FUNCTIONALITIES

- Solid-block construction in pure thermoplastic polymers, high mechanical strength and chemical resistance;
- Any kind of aggressive liquids can be pumped;
- Complete maintenance of the pump on-site (no disassembling needed);
- Optimised air consumption;
- Smart PAD for regulate the flow;
- Pump casing unloading system;
- Non-return valve to protect the distributor from liquid;
- Double unloading with silencer integrated.



Port size: $\frac{1}{2}$ " - 1" - 1 1/2"

Wetted section



Temperatures	UPPE	+70°	-40°
	PTFE	+120°	-20°

QUANTUM'S PLUS



INNOVATIVE COMPONENTS

TECHNICAL DATA	DDQ 60 (1/2")	DDQ 160 (1")	DDQ 400 (1" 1/2)
Maximum Capacity Litres/Minute	60	160	400
Materials of Pump Housings & Central Block	UPPE • PTFE	UPPE • PTFE	UPPE • PTFE
Fluid connection	G 1/2" BSP	G 1" BSP	G 1 1/2" BSP
Air connection	G 1/4" BSP	G 3/8" BSP	G 1/2" BSP
Max delivery head	80 mca	80 mca	80 mca
Max air pressure	8 bar	8 bar	8 bar
Max suction lift dry	4 mca	4 mca	4 mca
Max suction lift wet	9 mca	9 mca	9 mca
Max size solids	7,5 mm	11 mm	19 mm
Noise level	72 dB(A)	78 dB(A)	83 dB(A)

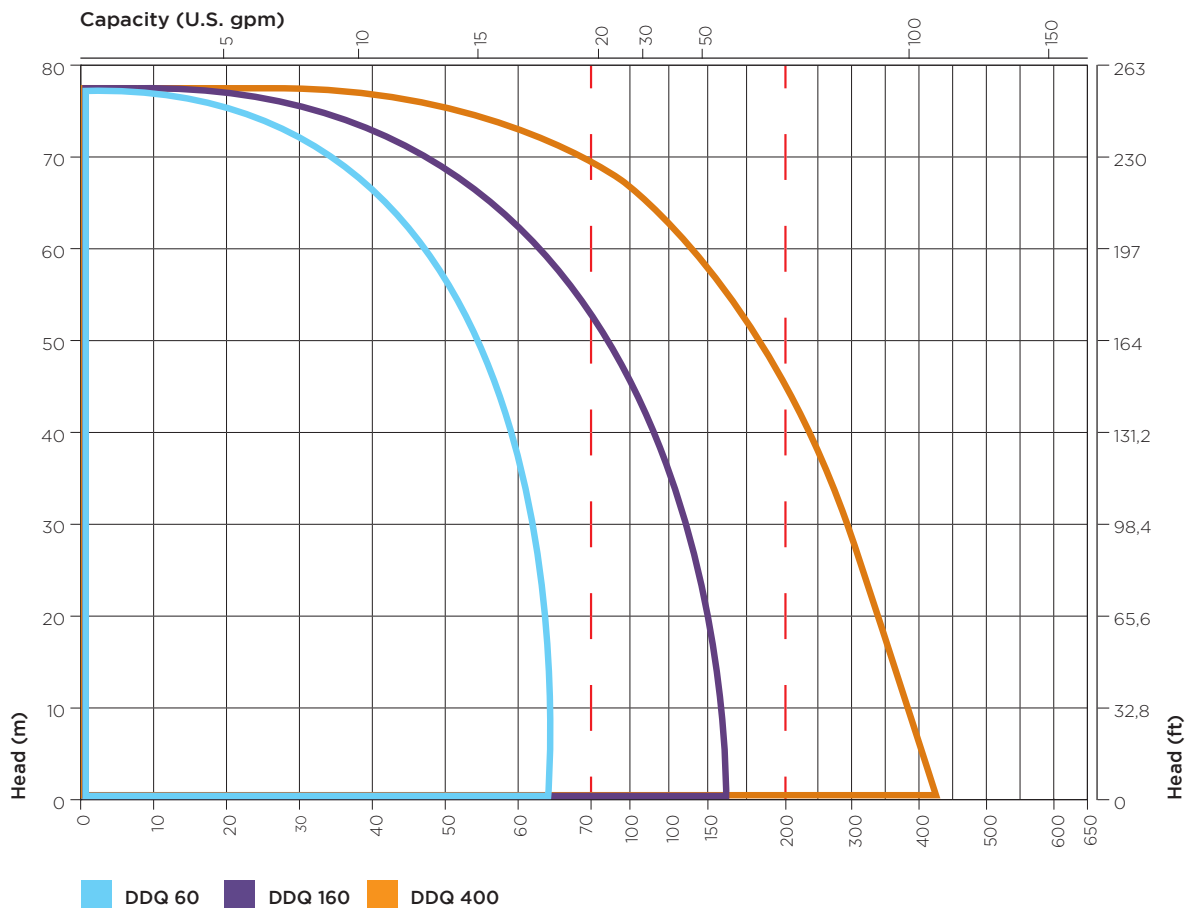

BENEFITS & FUNCTIONALITIES

- Solid-block construction in ultra high molecular weight polyethylene, high mechanical strength and chemical resistance;
- Optimised air consumption improved by a Modern air distribution system;
- Working sensitivity improved (start from 1 bar);
- Bigger inlet pipe for guaranteeing the best

- performance ever when pumping viscous liquids.
- Advanced caps for a longer lifecycle of the membranes and an easy maintenance;
- Distributor protected from atmospheric agents thanks to a free-acid armour;



Connections: 1/2" - 1" - 1 1/2" - 2"

Wetted sections

Temperatures UPPE +70° -40°

TECHNICAL DATA	DDS 30 (1/2")	DDS 100 (1")	DDS 400 (1 1/2")	DDS 650 (2")
Maximum Capacity Litres/Minute	52	130	370	715
Materials of Pump Housings & Central Block	UPPE	UPPE	UPPE	UPPE
Fluid connection	1/2" BSP • NPT • FLANGED DN15	1" BSP • NPT • FLANGED DN25	FLANGED DN40 • 1 1/2" BSP • NPT	FLANGED DN50 • 2" BSP • NPT
Air connection	G 1/4" BSP	G 3/8" BSP	G 1/2" BSP	G 3/4" BSP
Max delivery head	80 mca	80 mca	80 mca	80 mca
Max air pressure	8 bar	8 bar	8 bar	8 bar
Max suction lift dry	4 mca	4 mca	4.5 mca	4.5 mca
Max suction lift wet	9 mca	9 mca	9 mca	9 mca
Max size solids	3 mm	5.5 mm	7 mm	9 mm
Noise level	75 dB(A)	80 dB(A)	80 dB(A)	80 dB(A)

#AODD PUMPS INSTALLATIONS



FRANCE. Gypsum production plant
ASTRAevo (DDE 400 AISI316L) pump for liquid gypsum.

ITALY. Dairy industry
ASTRAevo (DDE 160 AISI316L) pump with pulsation dampener.



ITALY. Chemical plant
QUANTUM (DDQ 160) pump for unloading HF from reactors at 160°C.
MISTRALsolid (DDM 300 PE1000) pump with PE1000 pulsation dampener for the circulation of acids at 60°C.

ASIA. Off-shore platform
MISTRAL (DDM 200) pump for transferring water charged with oils during wastewater treatment phase.



ITALY.
MISTRAL (DDM 400 AISI316I) pumps for loading oily water.

ITALY. Mineral extraction (silice)
MISTRAL (DDM 400 AISI316L) pump for silice extraction.

#HORIZONTAL CENTRIFUGAL PUMPS

50HZ

The “chemical pumps” with horizontal axis by ARGAL® boast the following important features:

1 • Pump liquids with a specific gravity ranging between 1 and 2 kg/cm³ without having to reduce performance but by installing adequate horsepower engines;

2 • the use of E-CTFE such as fluoropolymer that offers a chemical resistance unparalleled when compared to any injection moulded polymer;

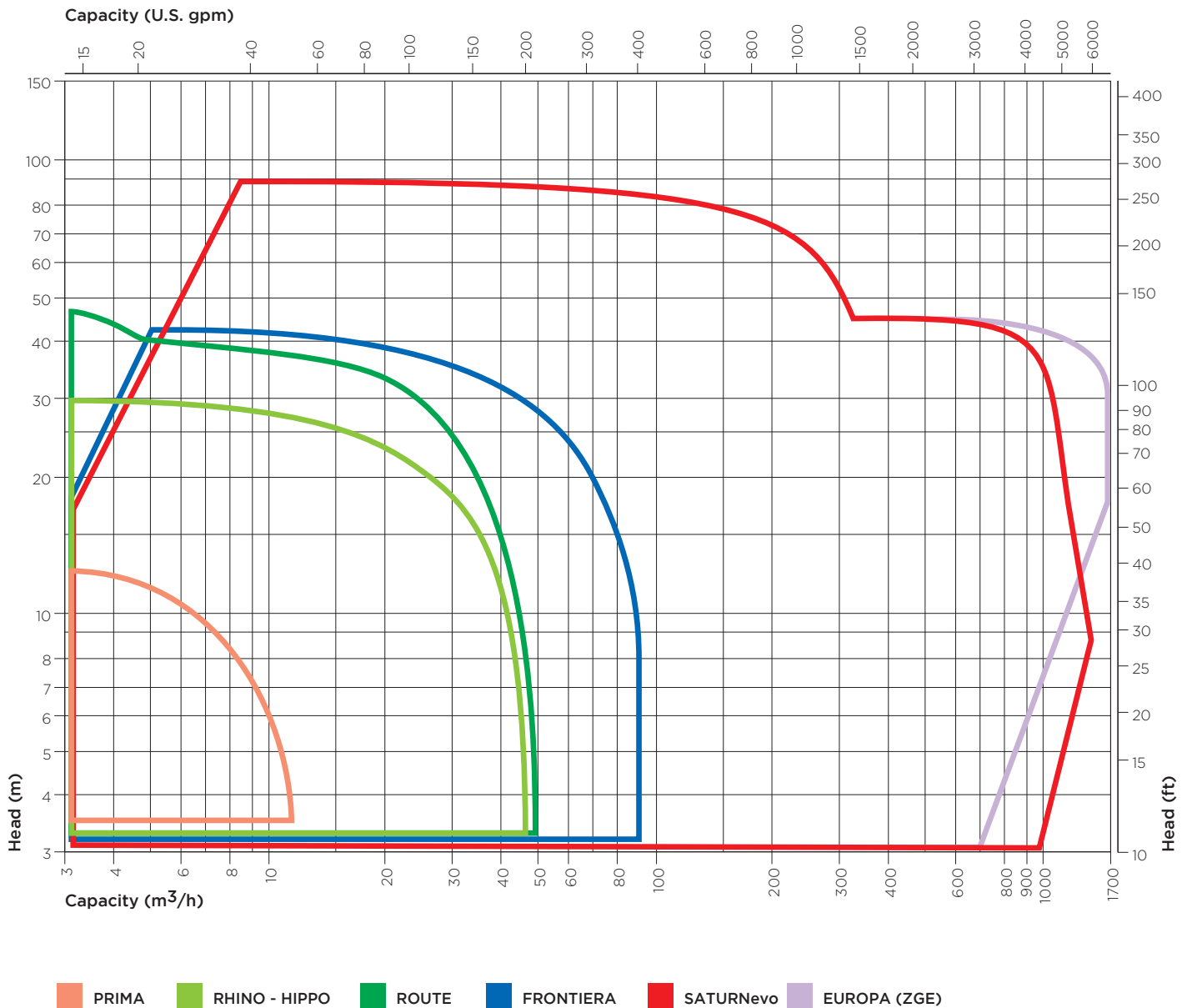

60HZ

#HORIZONTAL CENTRIFUGAL PUMPS

- 3 • up to 90 m³/h flow rate delivered by either magnetic drive pumps or mechanical sealed pumps;
- 4 • The close coupled pumps have stayed an additional bearing to support those of the

electric motor;

- 5 • All equipment involves the use of standardized electric motors.

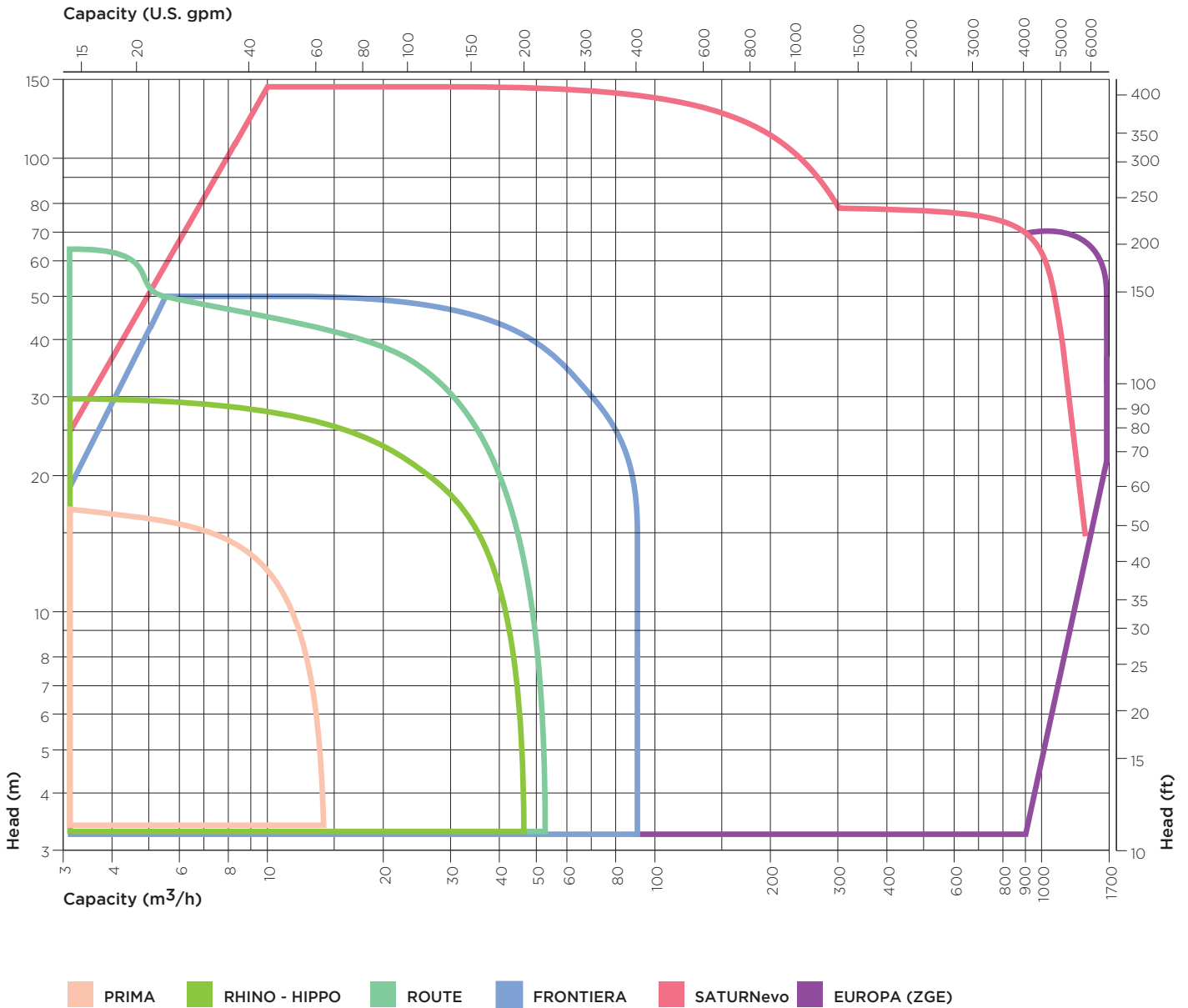

#HANDLING CENTRIFUGAL PUMPS

BASIS (TMB)



BENEFITS & FUNCTIONALITIES

- Compact design;
- Low noise;
- No sealing components ;
- Threaded and hose connections.



Capacity:	up to 70l/min.		
Construction:	Close-coupled mag-driven		
Motor powers:	W 15 ÷ 100		
Wetted section	PP	E-CTFE	(mod. TMB 35)
	+ Glass	+ Carbon	
Temperatures	PP+G	+60°	-5°
	ETFE+C	+90°	-20°

PRIMA (TMP)



BENEFITS & FUNCTIONALITIES

- No sealing components;
- No metallic part in contact with the liquid
- Threaded or flanged connections.

Capacity:	up to 12 m ³ /h		
Construction:	Close-coupled mag-driven		
Motor powers:	kW 0,18 ÷ 1,1		
Wetted section	PP	E-CTFE	
	+ Glass	+ Carbon	
Temperatures	PP+G	+60°	-5°
	ETFE+C	+90°	-20°



#HANDLING CENTRIFUGAL PUMPS

ROUTE (TMR • ZMR)



BENEFITS & FUNCTIONALITIES

- Mag-driven for clean liquids
- Mech-sealed for dirty or abrasive liquids ;
- Threaded or flanged connections .

Capacity:	up to 50 m ³ /h		
Construction:	Close-coupled mag-driven		
Motor powers:	kW 0,55 ÷ 11		
Wetted section	PP + Glass	E-CTFE + Carbon	
Temperatures	PP+G	+60°	-5°
	ETFE+C	+100°	-20°



Capacity:	up to 50 m ³ /h		
Construction:	Close-coupled mech-sealed		
Motor powers:	kW 0,55 ÷ 11		
Wetted section	PP + Glass	E-CTFE + Carbon	
Temperatures	PP+G	+60°	-5°
	ETFE+C	+100°	-20°



Patent for :
Bi-directional axial
self-alignment
system to allow the
dry-running.

The magnetic drive pump features the patented “bi-directional axial self-alignment system” which allows, for the “R” configuration, the dry running.

The combination of adequate materials of the driving system of the impeller with a specific magnetic field wholly eliminates all frontal frictions that are the cause of breakage when dry running. It is possible to couple standard motors without disassembling the pump.

#SELF-PRIMING CENTRIFUGAL PUMPS

The self-priming pumps made by **ARGAL®** boast the following important features:

- pumping liquids with a specific gravity ranging between 1 and 2 Kg/cm³ without reducing performance by installing electric motors of increased power;

- in magnetic versions, the use of E-CTFE such as fluoropolymer that offers an unparalleled chemical resistance when compared to other injection moulded polymers;
- Close-coupled pumps with standardized electric motors.

RHINO (TMA G2)



PLUS

- Reduced self-priming times;
- Biphasic impeller: for liquids with high density

- or high vapour pressure ;
- Up to 6m of self-prime.



Capacity: up to 17 m³/h
Construction: Close-coupled mag-driven
Motor powers: kW 2,2 ÷ 4

Wetted section

PP	E-CTFE
+ Glass	+ Carbon

Temperatures

PP+G	+60°	-5°
ETFE+C	+100°	-20°

BIPHASIC IMPELLER

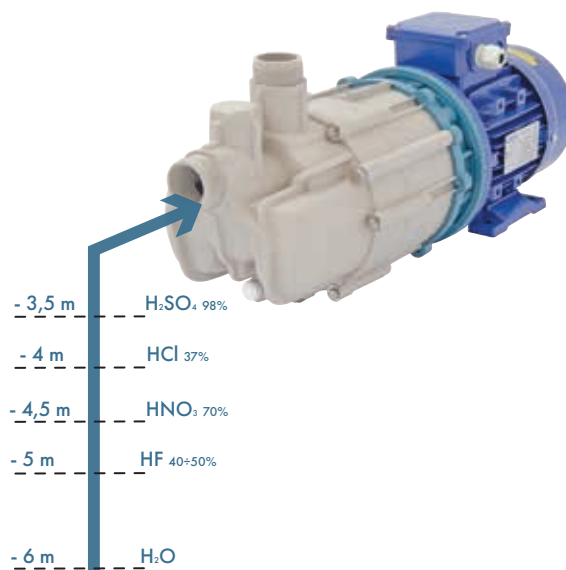

#SELF-PRIMING CENTRIFUGAL PUMPS

ELK (TMA G1)



PLUS

- Super reduced self-priming times;
- Reversible flow direction.
- Up to 6m of self-prime.

Capacity: up to 40 l/min
Construction: Close-coupled mag-driven
Motor powers: kW 0,55 ÷ 1,1

Wetted section

PP + Glass **E-CTFE** + Carbon

Temperatures

PP+G	+60°	-5°
ETFE+C	+100°	-20°



HIPPO (ZMA)



PLUS

- Solid-block construction in pure thermoplastic polymers;
- Suitable for laden liquids with solids;
- Up to 4,5m of self-prime.



Capacity: up to 50 m³/h
Construction: Close-coupled mech-sealed
Motor powers: kW 0,55 ÷ 7,5

Wetted section

U-PVC **PP** **PVDF**

Temperatures

U-PVC	+40°	0°
PP	+70°	-10°
PVDF	+100°	-30°

MECHANICAL SEALS



#CENTRIFUGAL INSTALLATIONS



CHINA. ASP oil recovery plant - BASIS pumps for recirculation of percolates.



KUWAIT. Power plant - ROUTE pump for unloading NaOH.



ITALY. Storage battery plant - ROUTE pumps for the circulation of acids into batteries.



ITALY. Desalination plant
ROUTE pumps for transferring Sodium Hypochlorite for seawater electrochlorination processes.

THAILAND. Aquarium
ROUTE pump for circulation of seawater for small size pools



#SELF-PRIMING INSTALLATIONS



ITALY. Precious metal plant - RHINO (TMA G2) pump for wastewater transfer.



INDONESIA. Chemical plant - ELK (TMA G1) pumps for transferring water charged with toxic agents.



SWITZERLAND. Garage - RHINO (TMA G2) pumps for unloading wastewater containing cleaning products, oils and acids.

#ISO 2858 STANDARD CENTRIFUGAL PUMPS

FRONTIERA (TGF • TMF • ZGF • ZMF)



BENEFITS & FUNCTIONALITIES

- ISO 2858 standard;
- Mech-sealed or mag-driven;
- Close or long coupled;
- External armour made of AISI 316 (optional);
- Backpull-Out (long-coupled version)
- Wet-end (mag-driven versions)
- Further bearing on motor side (close-coupled version only).

4 versions are available: 2 magnetic driven (TGF - TMF) and 2 mechanical sealed (ZGF - ZMF)

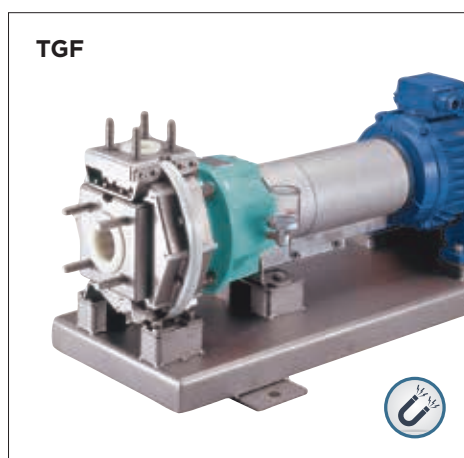

Capacity:	up to 90 m ³ /h		
Construction:	Close-coupled or long-coupled mag-driven		
Motor powers:	kW 0,55 ÷ 15		
Wetted section	PP	ETFE	
Temperatures	PP	+80°	-5°
	ETFE	+100°	-20°

Capacity:	up to 90 m ³ /h		
Construction:	Close-coupled or long-coupled mech-sealed		
Motor powers:	kW 0,55 ÷ 15		
Wetted section	PP	ETFE	
Temperatures	PP	+80°	-5°
	ETFE	+100°	-20°



The pump casing is made of fluoropolymer with a 8-10mm nerve thickness should be covered with an AISI 316 armour. These materials ensure the maximum protection level and chemical resistance.

#ISO 2858 STANDARD CENTRIFUGAL PUMPS

EUROPA (ZGE)



PLUS

- ISO 2858 standard;
- Solid-block construction in pure thermoplastic polymers, outside armour in cast iron;
- Backpull-Out
- High capacity.

Capacity:	up to 1.700 m ³ /h		
Construction:	Long-coupled mech-sealed		
Motor powers:	kW 0,5 ÷ 200		
Wetted section			
Temperatures	U-PVC	+40°	0°
	PP	+80°	-5°
	PVDF	+100°	-20°
	UPPE	+70°	-40°

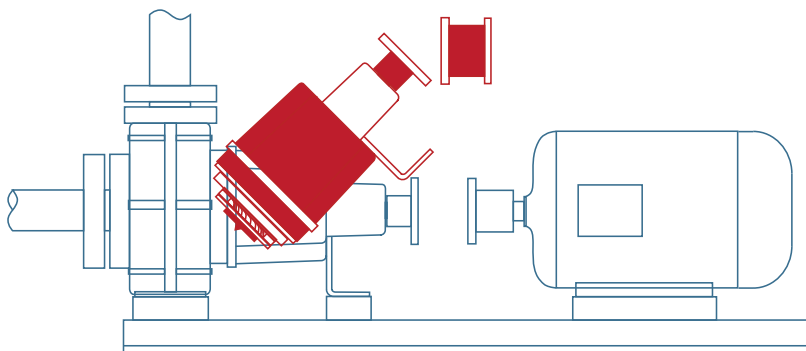

Back pull-out execution

All the pumps with elastic coupling are equipped with the back pull-out system that allows the dismantling of the internal and mechanic parts of the pump without disconnecting the casing from the fittings and without moving the motor.

A EUROPEAN FIRST

- Entirely made of vinyl ester resin (FRP);
- Abrasion and corrosion resistance ;
- Sturdy construction;
- Close or long-coupled;
- FRP impeller carbon filled;
- Feet and flanges reinforced in Kevlar;
- High efficiency and performance;
- ATEX version available (V1X).

SATURN evo pumps are available in two versions: ZGS (long-coupled), ZMS (close-coupled) and ZCS (compact close-coupled).

Capacity: up to 1.350 m³/h
Construction: Long-coupled mech-sealed
Motor powers: kW 1,5 ÷ 200

Wetted section

FRP

Temperatures +115° -35°

ZGS



ZMS



Capacity: up to 300 m³/h
Construction: Close-coupled mech-sealed
Motor powers: kW 1,5 ÷ 37

Wetted section

FRP

Temperatures +115° -35°

Capacity: up to 1.350 m³/h
Construction: Compact close-coupled mech-sealed
Motor powers: kW 1,5 ÷ 37

Wetted section

FRP

Temperatures +115° -35°

ZCS



#CENTRIFUGAL PUMPS FRP STANDARD ANSI B 73.1

SATURN_{sump} (KGS)

A EUROPEAN FIRST

- Entirely made of vynilester resin (FRP);
- High efficiency and performance;
- FRP Impeller carbon filled;
- Screws made of FRP, AISI 316L or titanium
- External flushing;
- Shaft made of AISI 316 or Duplex;
- ATEX version available.

Column length under plate up to 5 meters.



Capacity: up to 1350 m³/h
Motor powers: kW 1,5 ÷ 55

Material of submerged parts

FRP

Temperatures +100° -10°



FIBERGLASS IMPELLER
WITH CARBON-FIBER
BLADES CORE



STRAINER

#ISO 2858 INSTALLATIONS



ITALY. Desalination plant

FRONTIERA (ZMF) for transferring Sodium Hypochlorite to seawater electrochlorination process.



SOUTH AFRICA. Fume scrubber

FRONTIERA (TMF) for the circulation of a cleaning solution with nitric acid at 70°C

#ANSI B 73.1 FRP INSTALLATIONS



THAILAND. Aquaculture plant - for supplying the seawater tanks



USA. Aquarium -
for transferring seawater



ITALY. Aquatic park
for salt water pool



CHINA. Hotel Resort with aquarium and swimming pools -
for the circulation of seawater to the various pools



INDONESIA. Safari park
for supplying the main pool with seawater



THAILAND. Electrochlorination plant
for the dosing of Sodium Hypochlorite and
seawater.

#SUMP CENTRIFUGAL PUMPS

The sump pumps made by **ARGAL®** boast the following important features:

- Pump liquids with a specific gravity ranging between 1 and 2 kg/cm³ reducing performance by installing electric motor of adequate power rating;
- combinations of immersed bushing to guide the shaft in anti-abrasion materials;

- effective vapour sealing systems to protect mechanical parts;
- pump column reinforced in FRP (for strength and elongation containment);
- exclusive use of standardized electric motors also for monobloc constructions.
- Ex-proof (ATEX) version available.

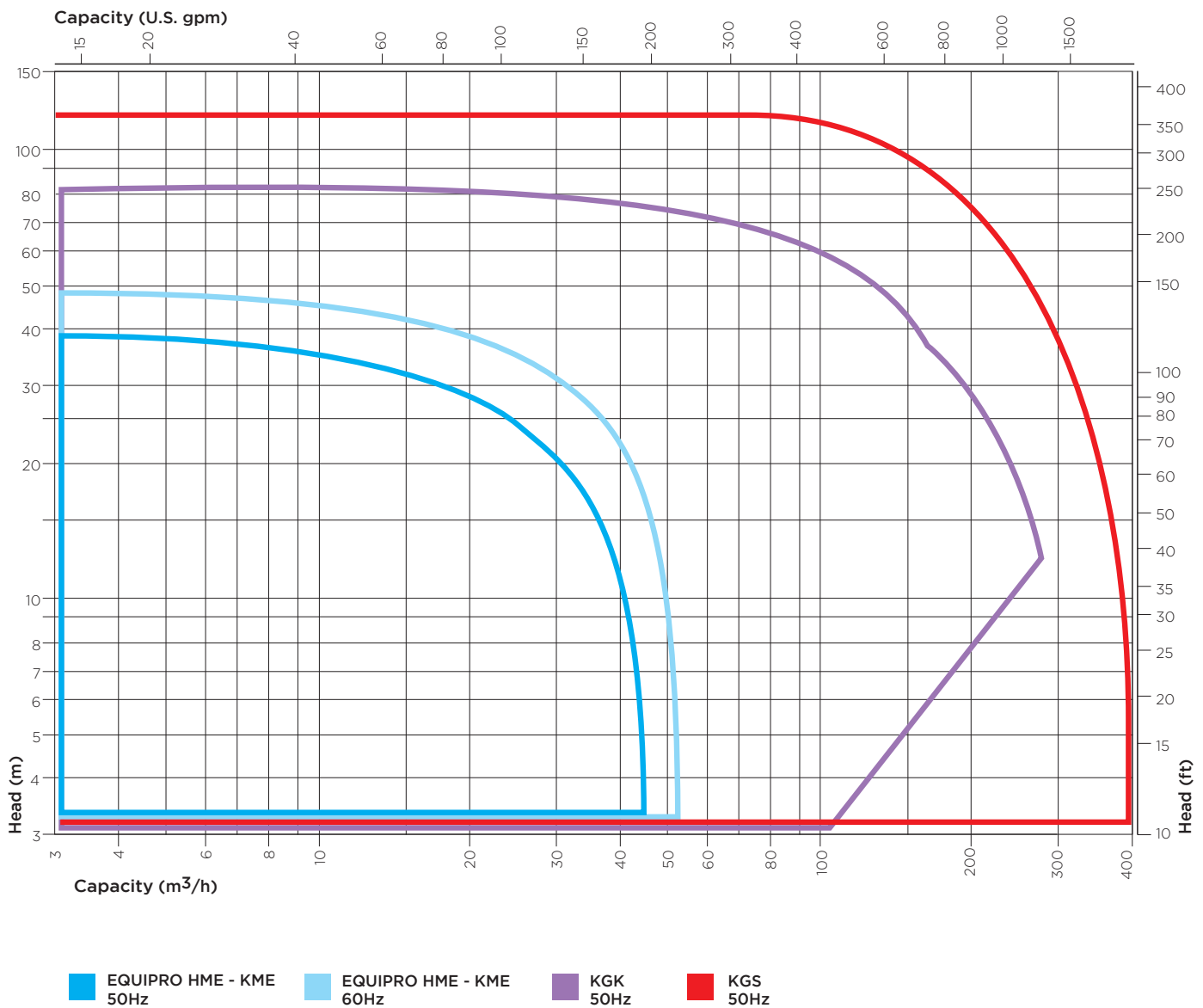

#SUMP CENTRIFUGAL PUMPS

EQUIPRO (HME)



- Cantilever pump ideal for laden liquids with solids;
- Column length under plate mm 275 or 450;

- Dry vapour steam seal;
- Inside or outside installation.

Capacity: up to 50 m³/h
Motor powers: kW 0,25 ÷ 7,5

Wetted section

PP

+ Glass

PVDF

+ Carbon

Temperatures

PP+G*

+60°

0°

PVDF+C*

+90°

-10°

* (to be reduced as function of column length)



EQUIPRO (KME)



- Guide system with SIC and CER bushing;
- The under plate column length up to 1,5 meters;

- Dry vapour steam seal;
- Easy assembling and IEC motor alligment.



Capacity: up to 50 m³/h
Motor powers: kW 0,55 ÷ 11

Wetted section

PP

+ Glass

PVDF

+ Carbon

Temperatures

PP+G*

+60°

0°

PVDF+C*

+90°

-10°

* (to be reduced as function of column length)

#SUMP CENTRIFUGAL PUMPS

K2 (KGK)



- No metal parts in contact with the fluid (screw included);
- CER and SIC guide system with external flushing;
- Pumping laden media with solids;
- The under plate column length up to 4 meters.
- FRP column to handling thermal dilatation;
- Sump column up to 4m;
- Semi-axial impeller (G3 size);
- Single or double stage.

ATEX VERSION AVAILABLE.



Capacity: up to 275 m³/h
Motor powers: kW 0,55 ÷ 45

Wetted section

PP
+ Glass

PVDF
+ Carbon

Material of submerged parts

PP

PP + FRP

PVDF

PVDF + FRP

Temperatures

PP+G +60° 0°
(to be reduced as function of column length)

PP+FRP +70° 0°

PVDF+C +90° -10°
(to be reduced as function of column length)

PVDF+FRP +90° -10°

#SUMP PUMPS INSTALLATIONS



SOUTH AFRICA. Wire pickling plant
EQUIPRO (HME) for transferring strong acids from a tank to another.



SOUTH AFRICA. Emergency chlorine fume scrubber
K2 (KGK) for transferring wastewater containing chloride.



ITALY. Fume scrubber plant
K2 (KGK) & EQUIPRO (KME) for conveying cleaning solution for taking off toxic gases from liquids.



POLAND. Sulfate ammonia production plant
K2 (KGK) for transferring ethelensanole.



ITALY. Pickling plant
K2 (KGK) for transferring concentrated hydrochloric acid.

#NOTES

Copyright © 2022 by ARGAL S.R.L

All rights reserved. No part of this catalog may be reproduced, distributed, or transmitted in any form or by any means, including photocopying, recording, or other electronic or mechanical methods, without the prior written permission of ARGAL S.R.L.

For permission requests, write to ARGAL Marketing Department, at marketing@argalpumps.com.

MAG-DRIVE &
MECH-SEALED
CENTRIFUGAL
PUMPS

ARGAL AIR

AIR-METERING &
AODD PUMPS
PULSATION
DAMPENERS

VERTICAL SUMP
PUMPS



ARGAL srl
Via Labirinto, 159 - 25125 BRESCIA
Tel. 030 3507011 | info@argalpumps.com
www.argalpumps.com



SELF-PRIMING
PUMPS